



香港中文大學

The Chinese University of Hong Kong

CSCI2510 Computer Organization

Lecture 01: Basic Structure of Computers

Ming-Chang YANG

mcyang@cse.cuhk.edu.hk

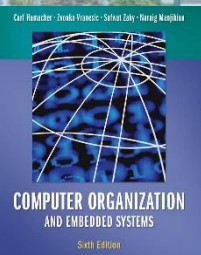

Reading: Chap. 1.1~1.3



- Computer: Tools for the Information Age
- Basic Functional Units of a Computer
 - Input Unit
 - Output Unit
 - Memory Unit
 - Arithmetic and Logic Unit
 - Control Unit
- Basic Operational Concepts
 - Instruction

What are computers used for?



Computer Types (1/4)



- **Personal Computer:** used by dedicated **individual** with the support of a variety of applications.
 - Mobile Computer
 - Notebook Computer
 - Desktop Computer
 - Workstation Computer



<https://www.titancomputers.com/Titan-X150-Intel-Xeon-E3-1200-V3-Series-Video-Ed-p/x150.htm>
<https://www.qvcuk.com/Apple-iMac-27%22-5K-Retina-w-Intel-Core-i5-8GB-RAM%2C-1TB-HDD-%26-2yr-Tech-Support.product.508688.html>
<https://www.amazon.ca/Microsoft-Surface-NVIDIA-GeForce-graphics/dp/B0163GS05Q>
<https://www.appworldin.com/product/ipad-pro-12-9inch-wifi-cellular-256gb-gold/>
<https://gadgets.ndtv.com/apple-iphone-x-4258>

Computer Types (2/4)



- **Servers and Enterprise Systems:** meant to be shared by a potentially **large number of users**.



- **Supercomputers:** the most expensive computers used for the **highly demanding computations**.



<https://www.anandtech.com/show/12124/dell-emc-launches-poweredge-xr2-rugged-server-1u-44-cores-512-gb-ram-30-tb-storage>
<https://www.verdict.co.uk/countries-supercomputers-world/>

Computer Types (3/4)



- **Grid Computers:** a cost-effective alternative composed of a large number of personal computers in a physically **distributed high-speed network**.

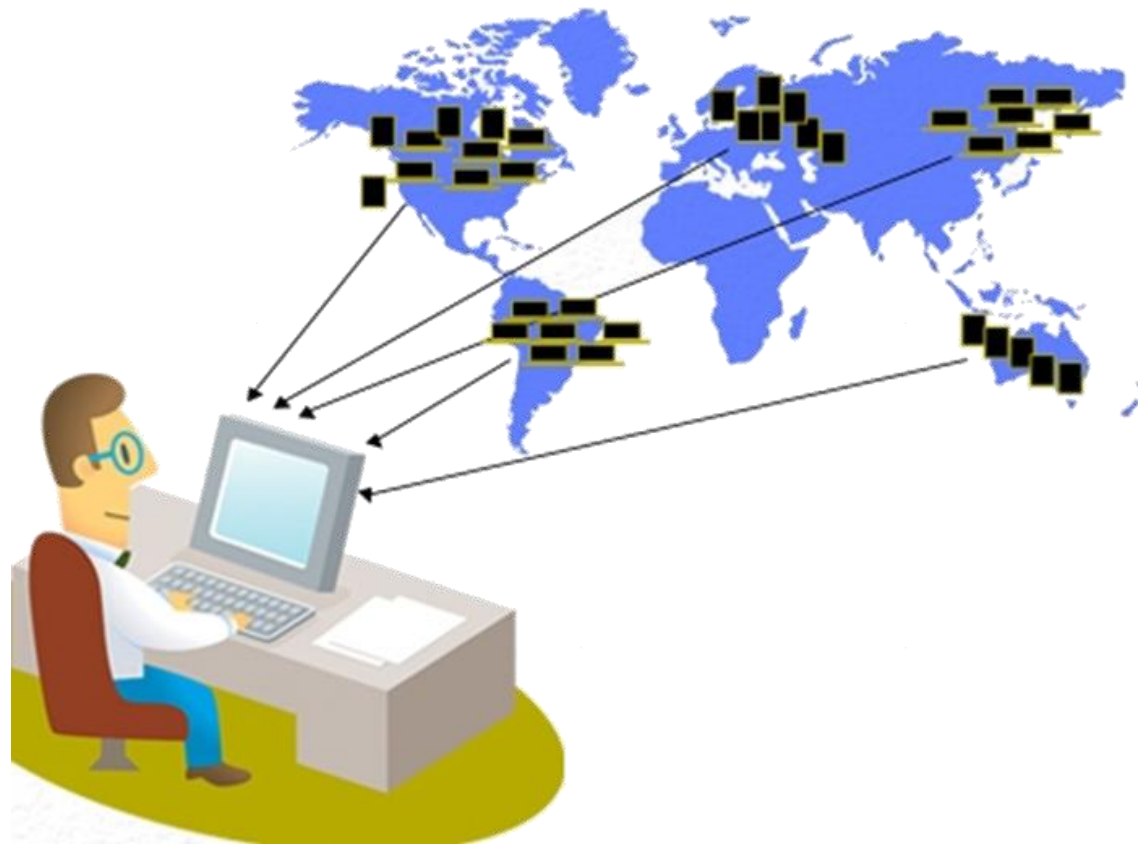

Computer Types (4/4)



- **Embedded Computers:** *integrated* into a device and used for a specific purpose.



Industrial Robots



GPS Receivers



Digital Cameras



Set top Boxes



Gaming Consoles



Photocopiers

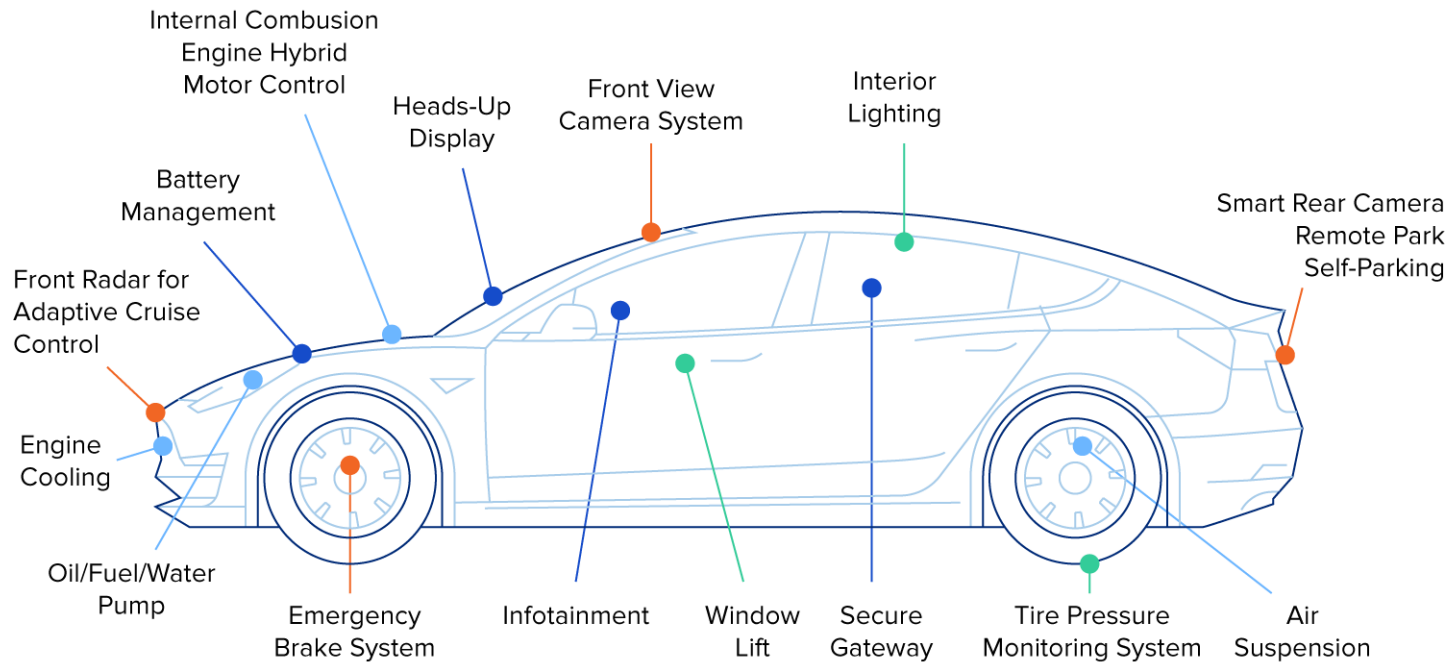

<https://www.rs-online.com/designspark/applications-of-embedded-systems-1>
<https://www.toptal.com/insights/agile-talent/embedded-systems-design-agile-talent>



- Computer: Tools for the Information Age
- **Basic Functional Units of a Computer**
 - Input Unit
 - Output Unit
 - Memory Unit
 - Arithmetic and Logic Unit
 - Control Unit
- Basic Operational Concepts
 - Instruction

What is inside a computer?

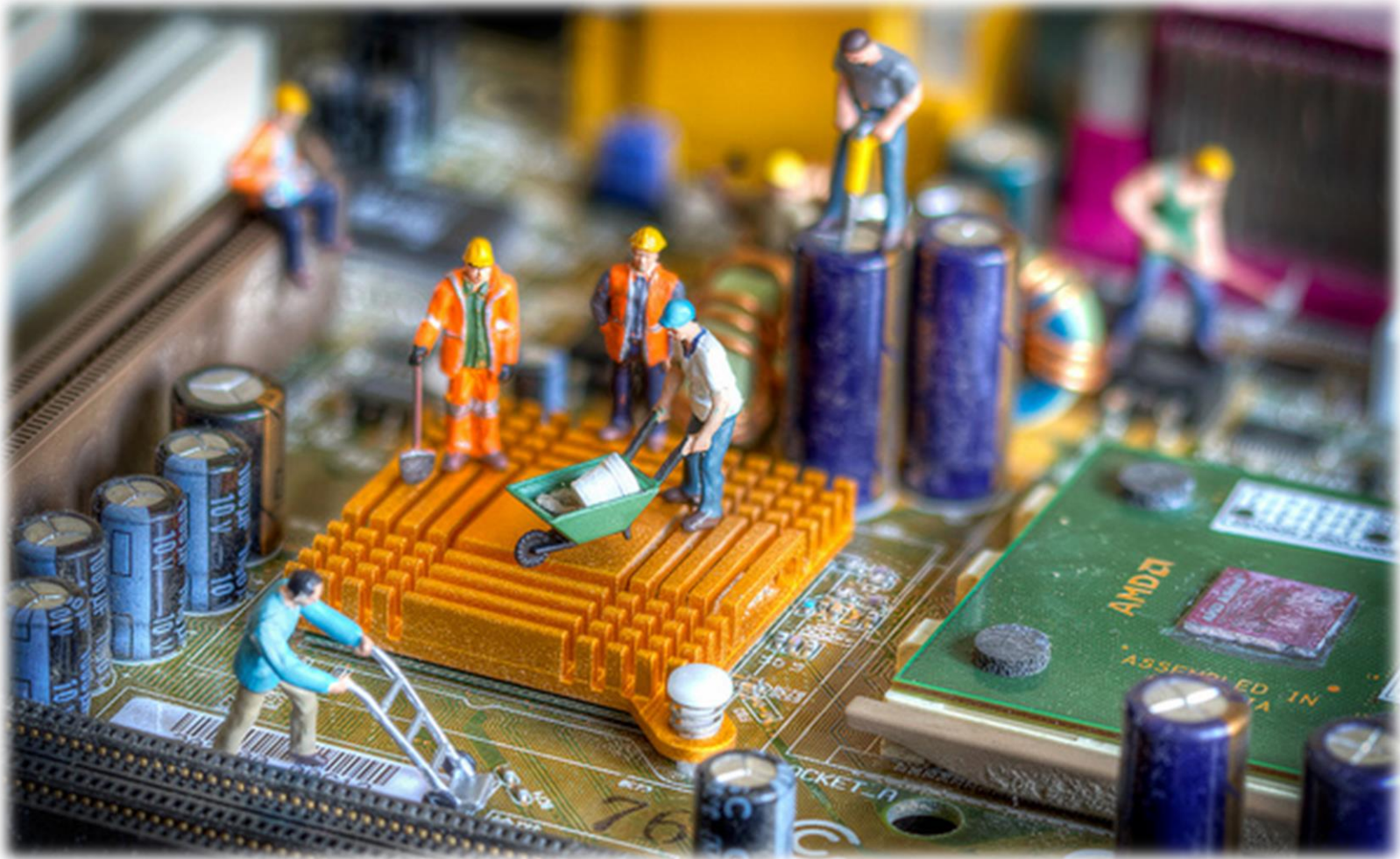

<https://itexperts.co.za/8-things-happening-inside-computer-box/>

Math Quiz!



- Try to answer the following questions:

Q1. $4 \times 7 + 5 = ?$

(A) 19 (B) 48 (C) 33 (D) 29

Q2. $3 - 3 \times 2 + 9 = ?$

(A) 3 (B) 6 (C) 9 (D) 12

Q3. $6 + 5 \times 8 - 1 \times (-3) = ?$

(A) 10 (B) 43 (C) 91 (D) 49



Basic Functional Units of a Computer

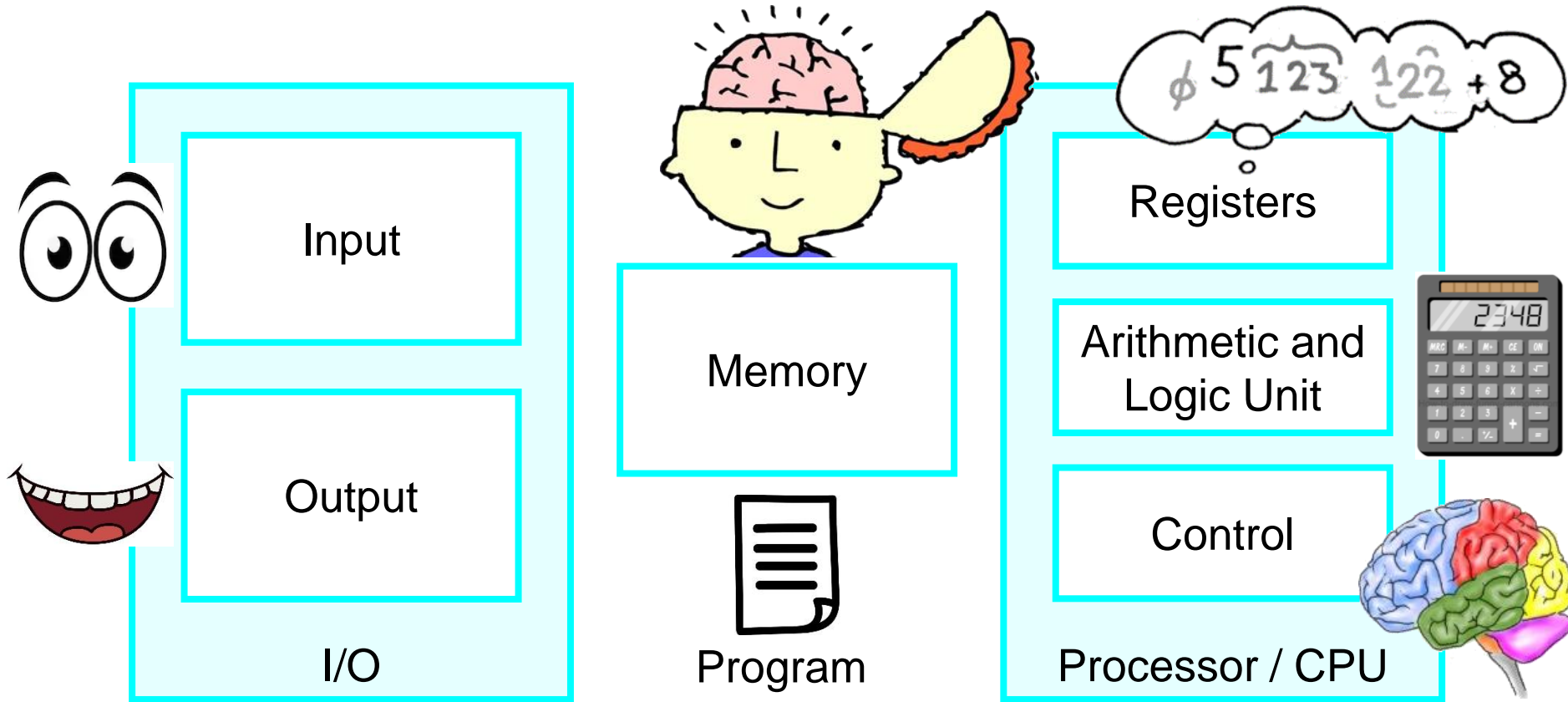

- **Input:** accepts coded information from human operators.
- **Memory:** stores the received information for later use.
- **Processor:** executes the **instructions** of a **program** stored in the memory.
- **Output:** sends back to the outside world.
- **Control:** coordinates all of these actions.

Class Exercise 1.1

Student ID: _____ Date: _____

Name: _____

- Question: Fill in the blanks in the below analogy table.

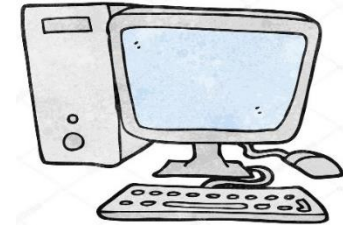
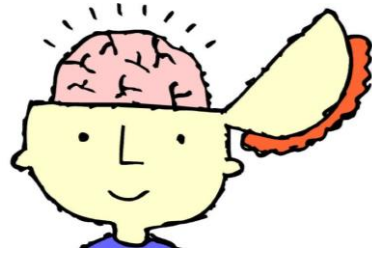

Math question ($4 \times 7 + 5$)

Multiple-choice answers

Arithmetic rules (x before +)

Multiplication table

Keeping numbers 4, 7, and 5

Temporary sum ($4 \times 7 = 28$)

Computation ($28 + 5 = 33$)

Execute rules (e.g., when to read input, when to compute and stop, etc.)

Overview: Input and Output Units



- **Input:** keyboard, mouse, microphone, CDROM, etc.
- **Output:** graphical display, printer, etc.
- The **collective term input/output (I/O)** units: input units, output units, disk drives, etc.

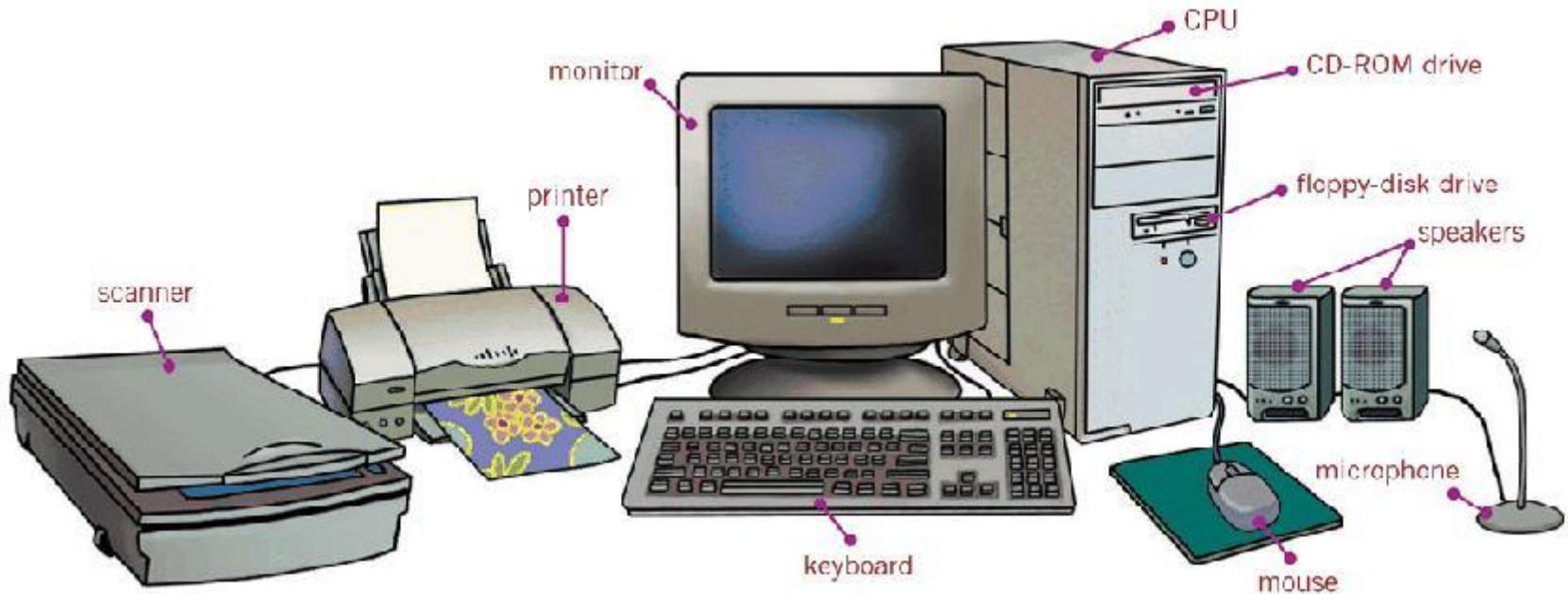

Overview: Memory Unit (Hierarchy)



- Memory is used to store **programs** and **data**.
- There are two classes of memory/storage:

- **Primary Memory** (also called **Main Memory**)

- A fast memory that operates at electronic speeds.
- Example: random-access memory (RAM)

- **Cache Memory**: A smaller, faster RAM to hold parts of a program (and data) that are currently being executed by CPU.

- **Secondary Storage**

- Primary memory is essential but expensive.
- Additional, less expensive, permanent secondary storage is used when large amounts of data and many programs have to be stored.
- Example: solid-state drive (SSD), hard disk (HDD), CD, DVD, etc.

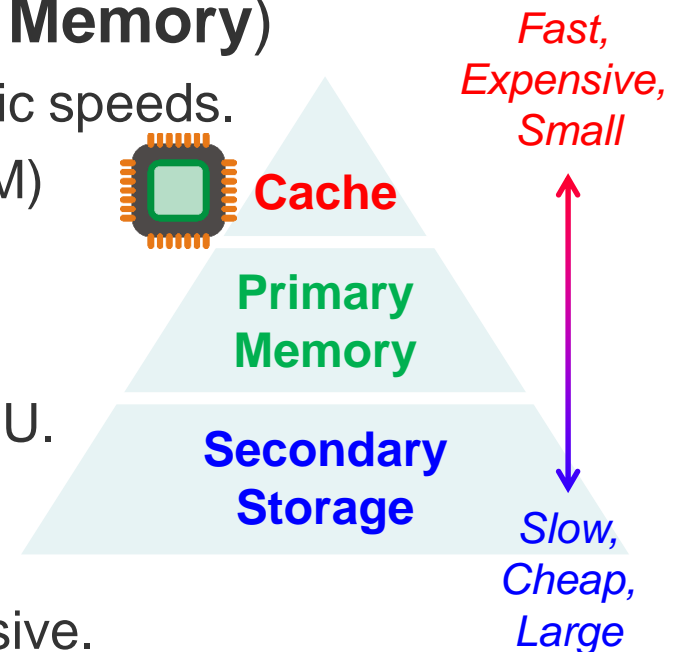

Overview: Processor



- **Registers**

- Very small but fast memory for storing intermediate values in a computation (inside the processor)

- **Arithmetic & Logic Unit (ALU)**

- Perform computations
 - Arithmetic Operations: add, subtract, multiply, divide, etc.
 - Logical Operations: and, or, not, etc.
 - Operands are stored in **registers**.

- **Control Unit**

- Control the transfer of data and sequencing of operations among memory, registers, ALU, I/O, etc.

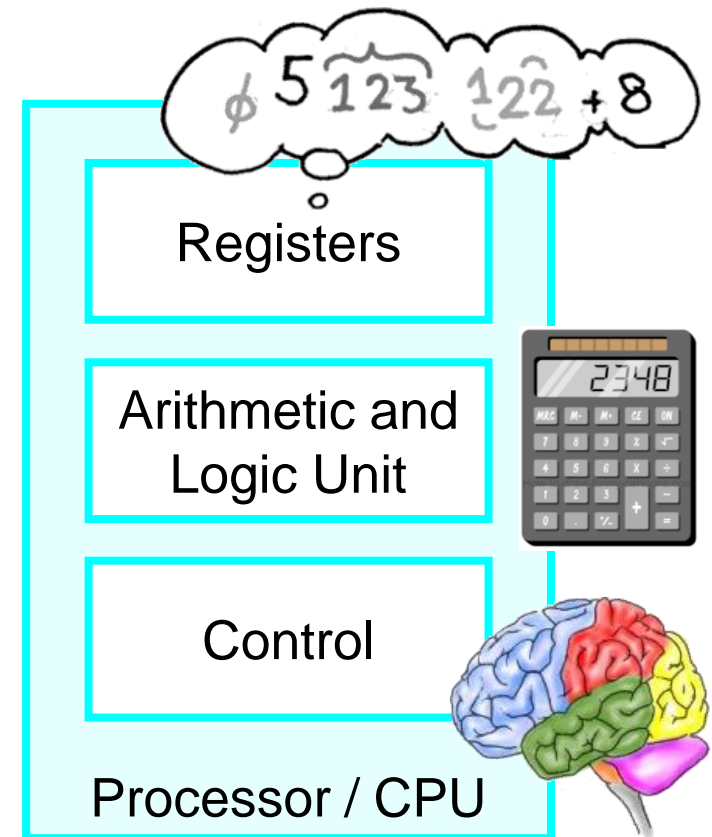

CPU on a Chip → Microprocessor

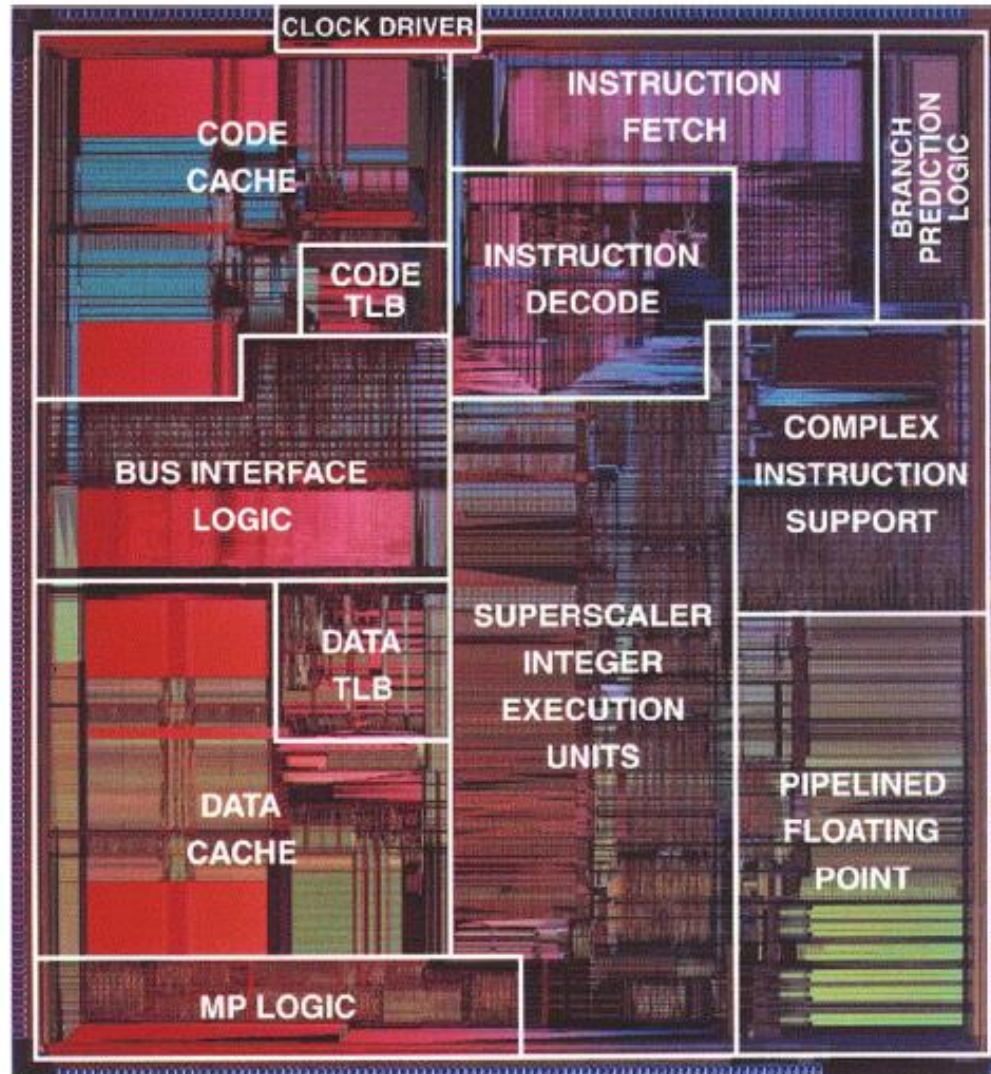



- Computer: Tools for the Information Age
- Basic Functional Units of a Computer
 - Input Unit
 - Output Unit
 - Memory Unit
 - Arithmetic and Logic Unit
 - Control Unit
- **Basic Operational Concepts**
 - **Instruction**

How to talk to the computer?

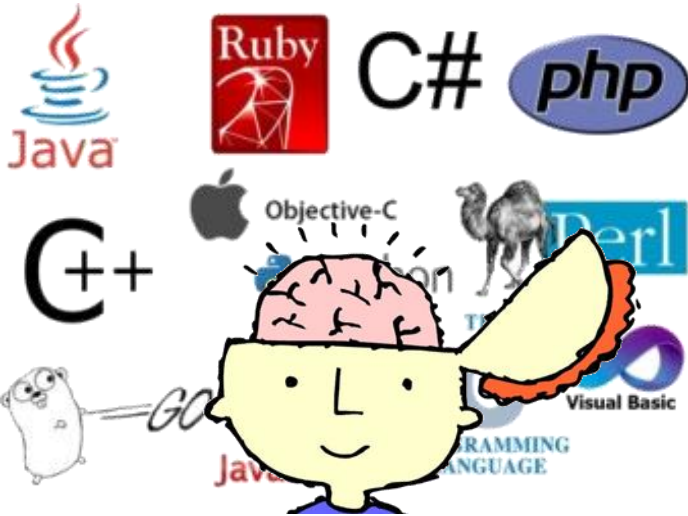

High-level Language

Easy for programmer to understand

Human understandable English words

Language Translation

Machine Language

The computer's own language

Binary numbers (All 1s and 0s)



Example of Language Translation



High-level Language

```
temp = v[k];  
v[k] = v[k+1];  
v[k+1] = temp;
```

```
TEMP = V(k);  
V(k) = V(k+1);  
V(k+1) = TEMP;
```

C/Java
Compiler

Fortran
Compiler

instructions!

Assembly Language

- lw**: loads a word from memory into a register
- sw**: saves a word from a register into RAM
- 0(\$2) : treats the value of register \$2 + 0 bytes as a location
- 4(\$2) : treats the value of register \$2 + 4 bytes as a location

```
lw $t0, 0($2)  
lw $t1, 4($2)  
sw $t1, 0($2)  
sw $t0, 4($2)
```

MIPS Assembler

Machine Language

```
0000 1001 1100 0110 1010 1111 0101 1000  
1010 1111 0101 1000 0000 1001 1100 0110  
1100 0110 1010 1111 0101 1000 0000 1001  
0101 1000 0000 1001 1100 0110 1010 1111
```



Activity in a Computer: Instruction



- A computer is governed by **instructions**.
 - To perform a given task, a **program** consisting of **a list of machine instructions** is stored in the memory.
 - Data to be used as **operands** are also stored in the memory.
 - Individual instructions are brought from the memory into the processor, which executes the specified operations.

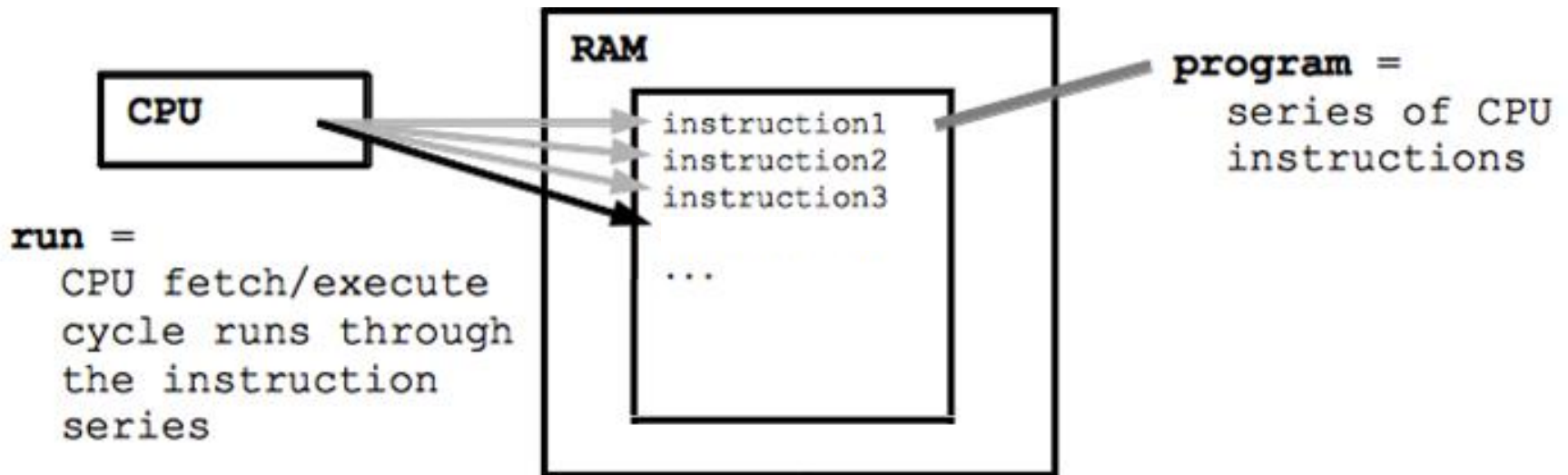

An Example of Program Execution



- Considering a program of 3 instructions:

PC → **Load R0, LOC**

- Reads the contents of a memory location LOC
- Loads them into processor register R0

– **Add R2, R0, R1**

- Adds the contents of registers R0 and R1
- Places their sum into register R2

– **Store R2, LOC**

- Copies the operand in register R2 to memory location LOC

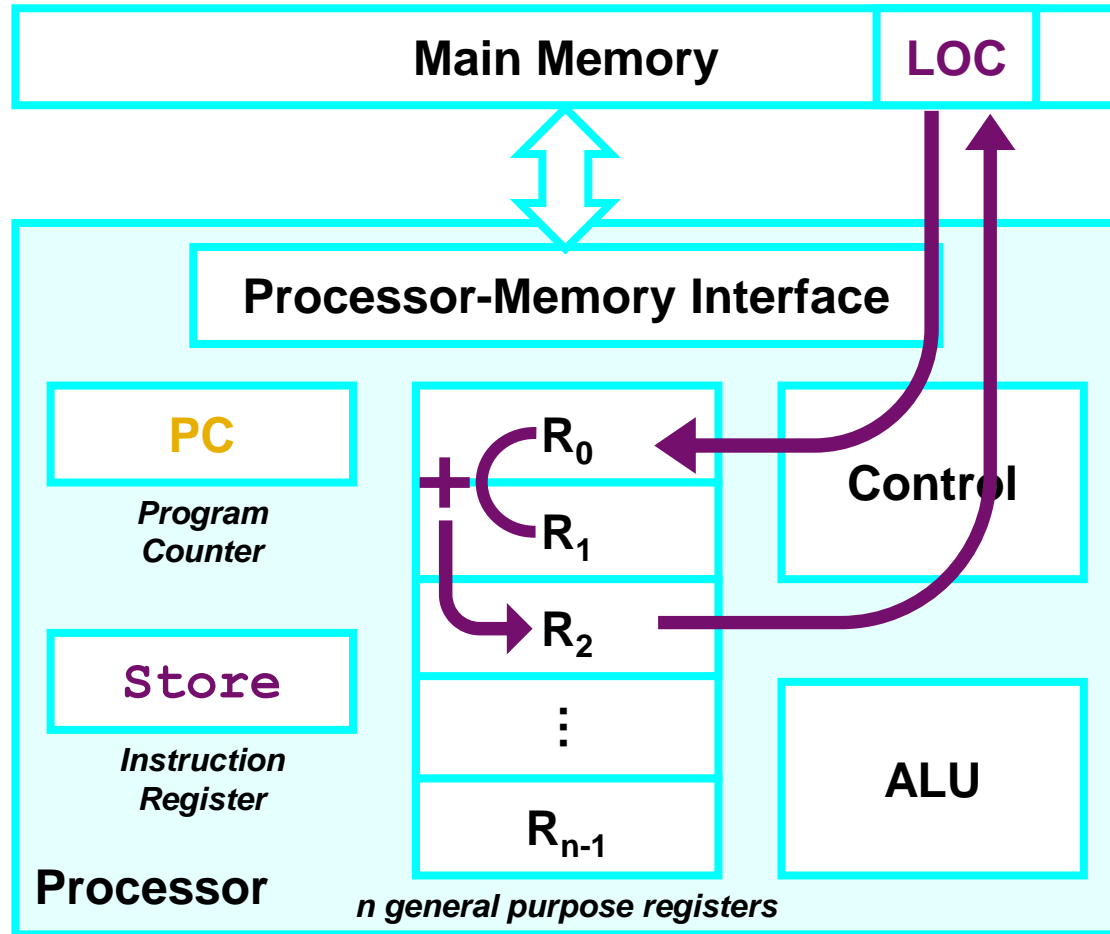

PC: contains the memory address of the next instruction to be fetched and executed.

IR: holds the instruction that is currently being executed.

R₀~R_{n-1}: n general-purpose registers.

Class Exercise 1.2



- Question: To execute the instruction **Load R2, LOC**, what should be the correct order of the following steps?
 - A. Send the address value of LOC from the instruction in register IR to the memory and issue a Read control command.
 - B. Wait until the requested word has been retrieved from the memory, then load it into register IR, where it is interpreted by the control circuitry to determine the operation to be performed.
 - C. Send the address of the instruction word from register PC to the memory and issue a Read control command.
 - D. Wait until the requested word has been retrieved from the memory, then load it into register R2.
 - E. Increment the contents of register PC to point to the next instruction in memory.
- Answer: _____

Class Exercise 1.3



- Question: Consider the following program, what does this program intend to do?
 - *Hint: Think about (1) use of registers, (2) implementation of the loop, (3) source, destination of operands*
- Answer: _____

| LABEL | OPCODE | OPERAND | COMMENT |
|-------------|--------------|---------|--------------------------------------|
| | CLEAR | R0 | <i>clear the sum</i> |
| | MOV | R2, 10 | <i>initialize the counter</i> |
| LOOP | INPUT | A | <i>input a new number</i> |
| | ADD | R0, A | <i>accumulate A into sum</i> |
| | DEC | R2 | <i>subtract one from the counter</i> |
| | JG | LOOP | <i>conditional branch</i> |
| | MOV | SUM, R0 | |



- Computer: Tools for the Information Age
- Basic Functional Units of a Computer
 - Input Unit
 - Output Unit
 - Memory Unit
 - Arithmetic and Logic Unit
 - Control Unit
- Basic Operational Concepts
 - Instruction